

Produkt - Information

Product Information Sheet

POWERTOWER

Kälte-Drucklufttrockner / Compressed Air Conditioner

Modell:	Model:	PT 760
----------------	---------------	---------------

Technische Daten	Technical Data		
Volumenstrom	Air Flow	m ³ /h / l/min	760 / 12.700
Elektr. Energieaufnahme	Electr. Power Consumption	kW	1,8
Energieversorgung	Power Supply	V / Hz / Ph	230 / 50 / 1
Stromaufnahme	Rated Adsorption	Ampere	9,5
Absicherung	Protection Fuse	Ampere	16
Luftanschluss	Air Connection	IN / OUT	G 2½ " i
Kondensatanschluss	Condensate Connection	OUT	G ¾ " i
Kaltemittel Typ/Menge	Coolant Type/Charge	Freon / kg	R 404a / 3,5
Kühlluftbedarf	Cooling Air Need	m ³ /h	2.400
Gewicht	Weight	kg	235

Standardausstattung	Standard Features		
Überwachungseinheit	Monitoring Unit	S8 DIGI LED Display	S8 DIGI LED Display
Energieregulung	Energy Regulation	Dauerbetrieb, ESA Energy Saver optional	continuous Operation; ESA Energy Saver optional
Kondensatableiter / Anz.	Condensate Drain / Qty.	BEKOMAT / 1	BEKOMAT / 1
Kondensator Kühlung	Condenser Cooling	luftgekühlt mit Ventilator	air cooled with Fan
Ventilatormotor	Ventilator Motor	saugender Ventilator	Suction Fan
Wärmetauscher	Heat Exchanger	Edelstahl- Plattenwärmetauscher	Stainless-Steel Plate-Heat-Exchanger
Verdampfer	Evaporator	Beruhigungsraum	Low Speed Chamber
Abscheider Prinzip	Separator Principle	Expansionsventil	Expansion Valve
Drosselorgan	Flue Damper	hermetisch geschlossen	hermetic Type
Kompressor Typ	Compressor Type	IP21	IP21
Elektrische Schutzklasse	Electrical Protection Class		

Betriebsbedingungen	Operating Conditions		
Max. Eintrittstemp.	Max. Air Inlet Temp.		50 °C
Zul. Umgebungstemp.	Perm. Ambient Temp.		2 – 43 °C
Max. Betriebsdruck	Max. Working Pressure		16 bar

Referenzbedingungen	Reference Datas		DIN/ISO 71831
DTP (Klasse 4)	PDP (Class 4)		3 °C
Volumenstrom in Relation	Air Flow in Relation		20 °C / 1 bar
Druckluft-Eintrittstemp.	Air Inlet Temp.		35 °C
Kühlmedium-Temp.	Cooling Media Temp.		25 °C
Betriebsdruck	Working Pressure		7 bar

Änderungen vorbehalten / Subject to change without notice

Letzte Aktualisierung / Last update: 04.06.2012

AGT Thermotechnik GmbH & Co.KG
 Richard-Lucas-Straße 6, D-41812 Erkelenz
 FON: +49 (0) 2431-9627-0, FAX: +49 (0) 2431-9627-31
 www.agt-thermotechnik.de info@agt-thermotechnik.de



Produkt - Information

Product Information Sheet

POWERTOWER

Kälte-Drucklufttrockner / Compressed Air Conditioner

Modell:	Model:	PT 760
----------------	---------------	---------------

Gehäuse	Housing		
Typ	Type	Standanlage	Ground Mounting
Abmaße - h/b/t1/t2	Dimensions - h/b/t1/t2	1350 mm / 800 mm / 670 mm / 600mm	
Abmaße - a/a1/a2/a3/a4	Dimensions - a/a1/a2/a3/a4	130mm / 216mm / 179mm / 323 mm / 106mm	
Abmaße - x	Dimensions - x	min. 800mm	

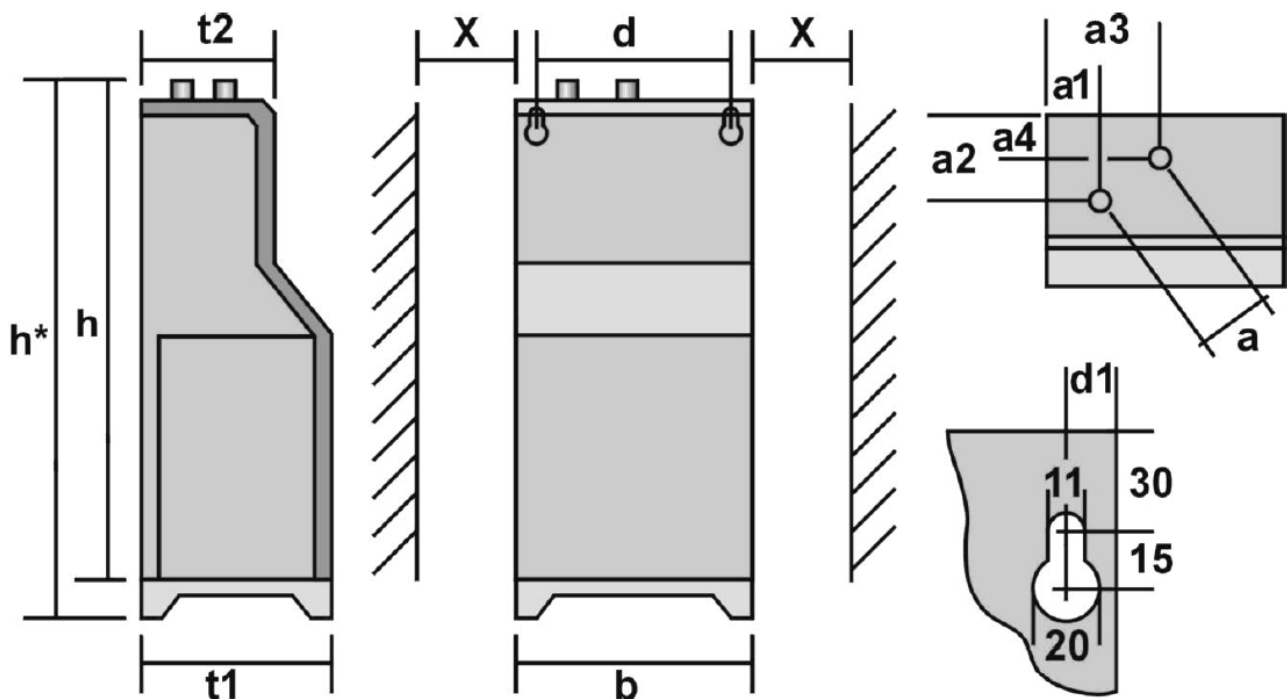

Änderungen vorbehalten / Subject to change without notice

Letzte Aktualisierung / Last update: 04.06.2012

AGT Thermotechnik GmbH & Co.KG
 Richard-Lucas-Straße 6, D-41812 Erkelenz
 FON: +49 (0) 2431-9627-0, FAX: +49 (0) 2431-9627-31
 www.agt-thermotechnik.de info@agt-thermotechnik.de

